



*American Maintenance Systems*



Problem: Safely cleaning in-service bleeder valves and instrument taps  
Solution: FLOW BOSS™ Cleaners



## FLOW BOSS™ Cleaners

Angle 90

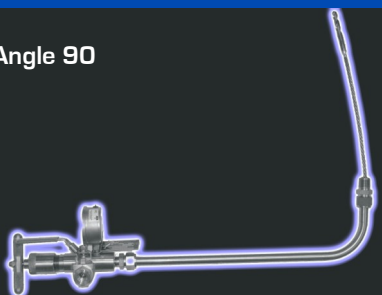

Angle 60

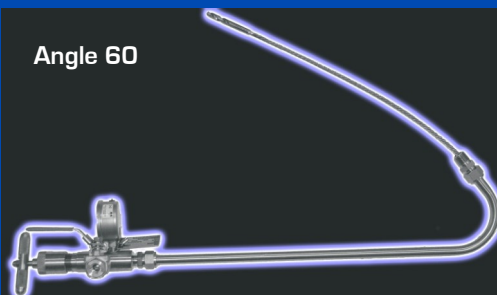

Straight

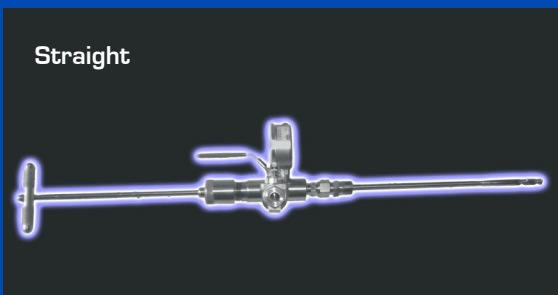

**FLOW BOSS™** Cleaners allow clogged bleeder, vent and instrument tap valves to be cleaned safely and efficiently while containing process material. These patent pending tools eliminate the hazards of dangerous fires, spills and vapor releases while performing these tasks. **FLOW BOSS™** is the only safe tool available to clean clogged instrument taps, drain valves, manifolds and orifice taps. Available in diameters of from 1/8" up to 5/8" and in lengths from 7 inches to 84 inches with end connections from 1/4" NPT to 1" NPT. Never again use a dangerous contraption that has no pressure gauge or vent valve to rod out valves and taps. The standard rod out device is the type 1 unless otherwise selected below.

Parts for these FLOW BOSS™ cleaners can be replaced in the field. Parts kits end the need for most factory service. Simply remove the nut on the handle plus the tube fitting at the body and remove the internal parts for complete field replacement in seconds. Parts kits are fully assembled at the factory and include end tube fitting, body tube fitting, tube, cutter, our unique wire rope, wire rope/push rod connector, safety stop (blow-out preventer), threaded push rod and nut for the angle models. Parts kits for the straight models include cutter, safety stop (blow-out preventer), threaded push rod and nut. We recommend a parts kit be obtained for each tool. When Parts Kits are needed simply add PK to the beginning of a model number. For example a model 6150L-84 requires PK6150L-84 parts kit.

Type 1, 0-14 pH, 700 deg F / 370 C, PSI 600 / 40 BAR (graphite)  
 Type 2, 0-14 pH, 350 deg F / 175 C, PSI 600 / 40 BAR (TFE)  
 Type 3, 0-14 pH, 1000 deg F / 535 C, PSI 1000 / 70 BAR (Graphoil)

Tools can be ordered in 1/4", 1/2", 3/4", 1" MNPT's

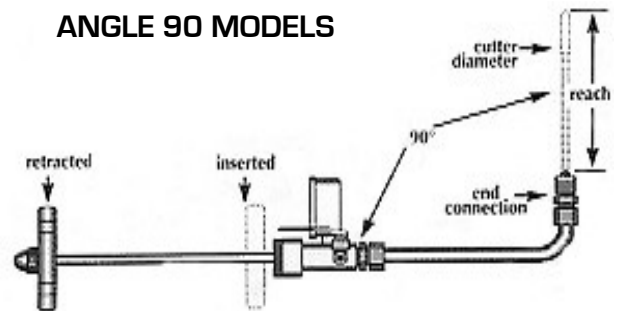
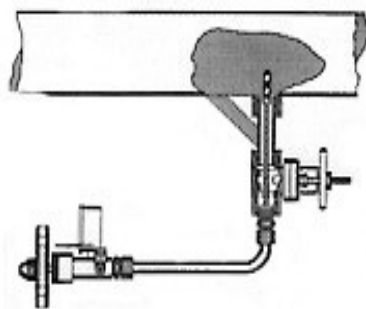
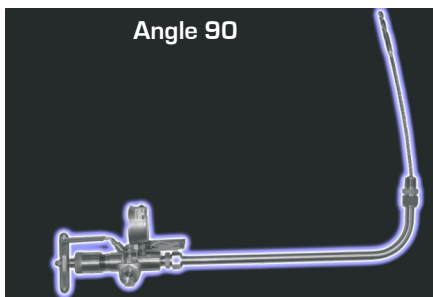

STD. MNPT	Description	Drill Dia.	Work Length	Model
1/4"	90 Deg Angle Tool	1/4" (6.5mm)	24"/60cm	2500-L-24"
1/4"	90 Deg Angle Tool	1/4" (6.5mm)	18"/45cm	2500-L-18"
1/4"	90 Deg Angle Tool	1/4" (6.5mm)	12"/30cm	2500-L-12"
1/4"	90 Deg Angle Tool	1/4" (6.5mm)	7"/17cm	2500-L-7"
1/2"	90 Deg Angle Tool	3/8" (9.5mm)	24"/60cm	3400-L-24"
1/2"	90 Deg Angle Tool	3/8" (9.5mm)	18"/45cm	3400-L-18"
1/2"	90 Deg Angle Tool	3/8" (9.5mm)	12"/30cm	3400-L-12"
1/2"	90 Deg Angle Tool	3/8" (9.5mm)	7"/17cm	3400-L-7"

316 Stainless Steel, for restrictions refer to ASME B40.1. Fittings & connectors, constructed of 316 Stainless Steel conform to ANSI B36.10, ANSI B1.20.1, MIL-P-7105 B, barstock material ASME SA479. Manufactured to API 570, ASME B31.3. All components supplied conform to ANSI, ASME, ASTM and ISO-9002



12407 N.Mopac Expressway, Suite 100-469, Austin, Texas 78758 USA  
 Telephone 512 238 0962 Fax 512 238 0961  
 E-mail [info@american-maintenance-systems.com](mailto:info@american-maintenance-systems.com)

Web [www.american-maintenance-systems.com](http://www.american-maintenance-systems.com)

Copyright AMS® 2009, all rights reserved

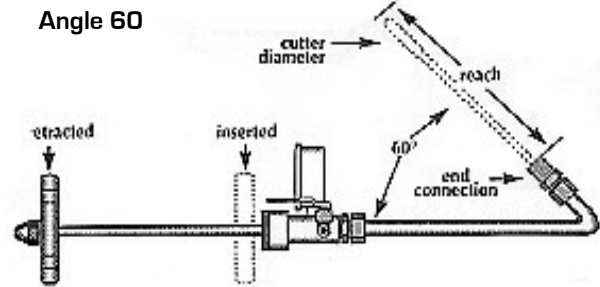
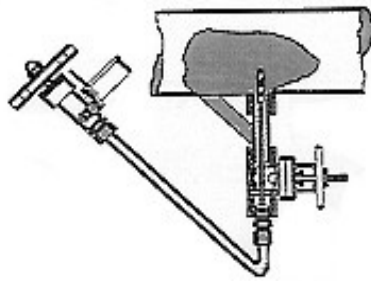
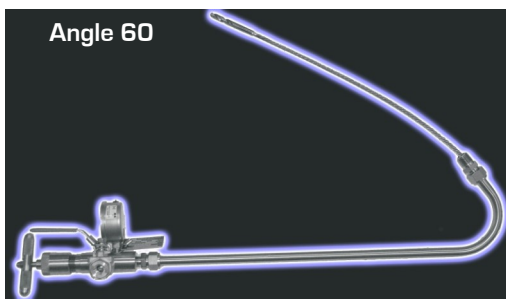

MNPT	Description	Drill Dia.	Work Length	Model
1/4"	60 Deg Angle Tool	1/4" (6.5mm)	24"/60cm	4300-L-24"
1/4"	60 Deg Angle Tool	1/4" (6.5mm)	18"/45cm	4300-L-18"
1/2"	60 Deg Angle Tool	3/8" (9.5mm)	24"/60cm	5200-L-24"
1/2"	60 Deg Angle Tool	3/8" (9.5mm)	18"/45cm	5200-L-18"

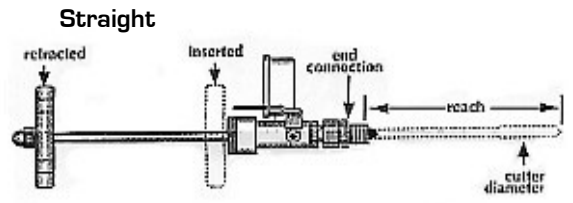
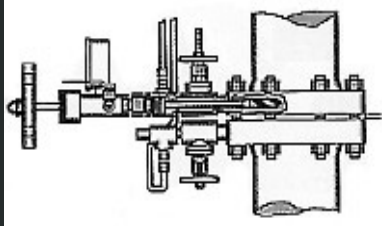
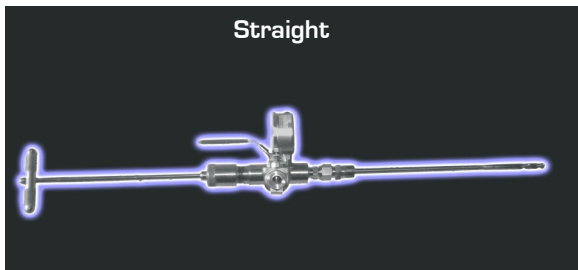

MNPT	Description	Drill Dia.	Work Length	Model
1/4"	Straight Tool	5/32" (4mm)	12" / 30cm	0750L-12"
1/4"	Straight Tool	5/32" (4mm)	7" / 17cm	0750L-7"
1/4"	Straight Tool	7/32" (5.5mm)	12" / 30cm	1650-L-12"
1/4"	Straight Tool	7/32" (5.5mm)	7" / 17cm	1650-L-7"
1/4"	Straight Tool	1/4" (6.5mm)	12" / 30cm	2550-L-12"
1/4"	Straight Tool	1/4" (6.5mm)	7" / 17cm	2550-L-7"
1/4"	Straight Tool	1/4" (6.5mm)	48"/120cm	4350-L-48"
1/4"	Straight Tool	1/4" (6.5mm)	36"/ 90cm	4350-L-36"
1/4"	Straight Tool	1/4" (6.5mm)	24"/ 60cm	4350-L-24"
1/4"	Straight Tool	1/4" (6.5mm)	18"/ 45cm	4350-L-18"
1/2"	Straight Tool	3/8" (9.5mm)	12"/ 30cm	3450-L-12"
1/2"	Straight Tool	3/8" (9.5mm)	7"/ 17cm	3450-L-7"
1/2"	Straight Tool	3/8" (9.5mm)	48"/120cm	5250-L-48"
1/2"	Straight Tool	3/8" (9.5mm)	36"/ 90cm	5250-L-36"
1/2"	Straight Tool	3/8" (9.5mm)	24"/ 60cm	5250-L-24"
1/2"	Straight Tool	3/8" (9.5mm)	18"/ 45cm	5250-L-18"
3/4"	Straight Tool	1/2" (13.5mm)	84"/210cm	6150-L-84"
3/4"	Straight Tool	1/2" (13.5mm)	72"/180cm	6150-L-72"
3/4"	Straight Tool	1/2" (13.5mm)	60"/150cm	6150-L-60"
3/4"	Straight Tool	1/2" (13.5mm)	48"/120cm	6150-L-48"
3/4"	Straight Tool	1/2" (13.5mm)	36"/ 90cm	6150-L-36"
3/4"	Straight Tool	1/2" (13.5mm)	24"/ 60cm	6150-L-24"
3/4"	Straight Tool	1/2" (13.5mm)	18"/ 45cm	6150-L-18"
3/4"	Straight Tool	1/2" (13.5mm)	12"/ 30cm	6150-L-12"
1"	Straight Tool	5/8" (15mm)	84"/210cm	7050-L-84"
1"	Straight Tool	5/8" (15mm)	72"/180cm	7050-L-72"
1"	Straight Tool	5/8" (15mm)	60"/150cm	7050-L-60"
1"	Straight Tool	5/8" (15mm)	48"/120cm	7050-L-48"
1"	Straight Tool	5/8" (15mm)	36"/ 90cm	7050-L-36"
1"	Straight Tool	5/8" (15mm)	24"/ 60cm	7050-L-24"
1"	Straight Tool	5/8" (15mm)	18"/ 45cm	7050-L-18"
1"	Straight Tool	5/8" (15mm)	12"/ 30cm	7050-L-12"

**REPLACEMENT PARTS KITS**

<b>STD. MNPT</b>	<b>Description</b>	<b>Drill Dia.</b>	<b>Work Length</b>	<b>Model</b>
1/4"	90 Deg Angle Kit	1/4" (6.5mm)	24"/60cm	PK-2500-L-24"
1/4"	90 Deg Angle Kit	1/4" (6.5mm)	18"/45cm	PK-2500-L-18"
1/4"	90 Deg Angle Kit	1/4" (6.5mm)	12"/30cm	PK-2500-L-12"
1/4"	90 Deg Angle Kit	1/4" (6.5mm)	7"/17cm	PK-2500-L-7"
1/2"	90 Deg Angle Kit	3/8" (9.5mm)	24"/60cm	PK-3400-L-24"
1/2"	90 Deg Angle Kit	3/8" (9.5mm)	18"/45cm	PK-3400-L-18"
1/2"	90 Deg Angle Kit	3/8" (9.5mm)	12"/30cm	PK-3400-L-12"
1/2"	90 Deg Angle Kit	3/8" (9.5mm)	7"/17cm	PK-3400-L-7"
1/4"	60 Deg Angle Kit	1/4" (6.5mm)	24"/60cm	PK-4300-L-24"
1/4"	60 Deg Angle Kit	1/4" (6.5mm)	18"/45cm	PK-4300-L-18"
1/2"	60 Deg Angle Kit	3/8" (9.5mm)	24"/60cm	PK-5200-L-24"
1/2"	60 Deg Angle Kit	3/8" (9.5mm)	18"/45cm	PK-5200-L-18"
1/4"	Straight Kit	5/32" (4mm)	12" / 30cm	PK-0750L-12"
1/4"	Straight Kit	5/32" (4mm)	7" / 17cm	PK-0750L-7"
1/4"	Straight Kit	7/32" (5.5mm)	12" / 30cm	PK-1650-L-12"
1/4"	Straight Kit	7/32" (5.5mm)	7" / 17cm	PK-1650-L-7"
1/4"	Straight Kit	1/4" (6.5mm)	12" / 30cm	PK-2550-L-12"
1/4"	Straight Kit	1/4" (6.5mm)	7" / 17cm	PK-2550-L-7"
1/4"	Straight Kit	1/4" (6.5mm)	48"/120cm	PK-4350-L-48"
1/4"	Straight Kit	1/4" (6.5mm)	36"/ 90cm	PK-4350-L-36"
1/4"	Straight Kit	1/4" (6.5mm)	24"/ 60cm	PK-4350-L-24"
1/4"	Straight Kit	1/4" (6.5mm)	18"/ 45cm	PK-4350-L-18"
1/2"	Straight Kit	3/8" (9.5mm)	12"/ 30cm	PK-3450-L-12"
1/2"	Straight Kit	3/8" (9.5mm)	7"/ 17cm	PK-3450-L-7"
1/2"	Straight Kit	3/8" (9.5mm)	48"/120cm	PK-5250-L-48"
1/2"	Straight Kit	3/8" (9.5mm)	36"/ 90cm	PK-5250-L-36"
1/2"	Straight Kit	3/8" (9.5mm)	24"/ 60cm	PK-5250-L-24"
1/2"	Straight Kit	3/8" (9.5mm)	18"/ 45cm	PK-5250-L-18"
3/4"	Straight Kit	1/2" (13.5mm)	84"/210cm	PK-6150-L-84"
3/4"	Straight Kit	1/2" (13.5mm)	72"/180cm	PK-6150-L-72"
3/4"	Straight Kit	1/2" (13.5mm)	60"/150cm	PK-6150-L-60"
3/4"	Straight Kit	1/2" (13.5mm)	48"/120cm	PK-6150-L-48"
3/4"	Straight Kit	1/2" (13.5mm)	36"/ 90cm	PK-6150-L-36"
3/4"	Straight Kit	1/2" (13.5mm)	24"/ 60cm	PK-6150-L-24"
3/4"	Straight Kit	1/2" (13.5mm)	18"/ 45cm	PK-6150-L-18"
3/4"	Straight Kit	1/2" (13.5mm)	12"/ 30cm	PK-6150-L-12"
1"	Straight Kit	5/8" (15mm)	84"/210cm	PK-7050-L-84"
1"	Straight Kit	5/8" (15mm)	72"/180cm	PK-7050-L-72"
1"	Straight Kit	5/8" (15mm)	60"/150cm	PK-7050-L-60"
1"	Straight Kit	5/8" (15mm)	48"/120cm	PK-7050-L-48"
1"	Straight Kit	5/8" (15mm)	36"/ 90cm	PK-7050-L-36"
1"	Straight Kit	5/8" (15mm)	24"/ 60cm	PK-7050-L-24"
1"	Straight Kit	5/8" (15mm)	18"/ 45cm	PK-7050-L-18"
1"	Straight Kit	5/8" (15mm)	12"/ 30cm	PK-7050-L-12"

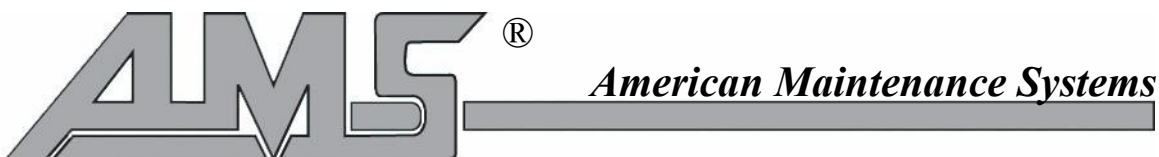

12407 N.Mopac Expressway, Suite 100-469, Austin, Texas 78758 USA  
 Telephone 512 238 0962 Fax 512 238 0961  
 E-mail [info@american-maintenance-systems.com](mailto:info@american-maintenance-systems.com)

Web [www.american-maintenance-systems.com](http://www.american-maintenance-systems.com)